

QLAS-8000-12000-54-15

8~12GHz, 54dB, 1.5dB



Features:
* Broadband
* Low Noise

Applications:
* Wireless
* Receiver
* Laboratory Test
* Radar

Electrical

Frequency:	8~12GHz
Gain:	54dB typ.
Gain Flatness:	±1dB typ.
Output Power (P1dB):	17dBm typ.
Noise Figure:	1.5dB typ.
Spurious:	-60dBc max.
VSWR:	2 typ.
Voltage:	+85~+265V AC
Current:	200mA typ.
Impedance:	50Ω

Mechanical

Size*2:	136*186*52mm 5.354*7.323*2.047in
RF Connectors:	SMA Female

[2] Exclude connectors, rack mount brackets, handles.

Environmental

Operating Temperature:	-20~+50°C
Non-operating Temperature:	-40~+85°C

How To Order

[QLAS-8000-12000-54-15](#)

Customization is available upon request.

Absolute Maximum Ratings*1

RF Input Power: +20dBm

[1] Permanent damage may occur if any of these limits are exceeded.

Outline Drawings

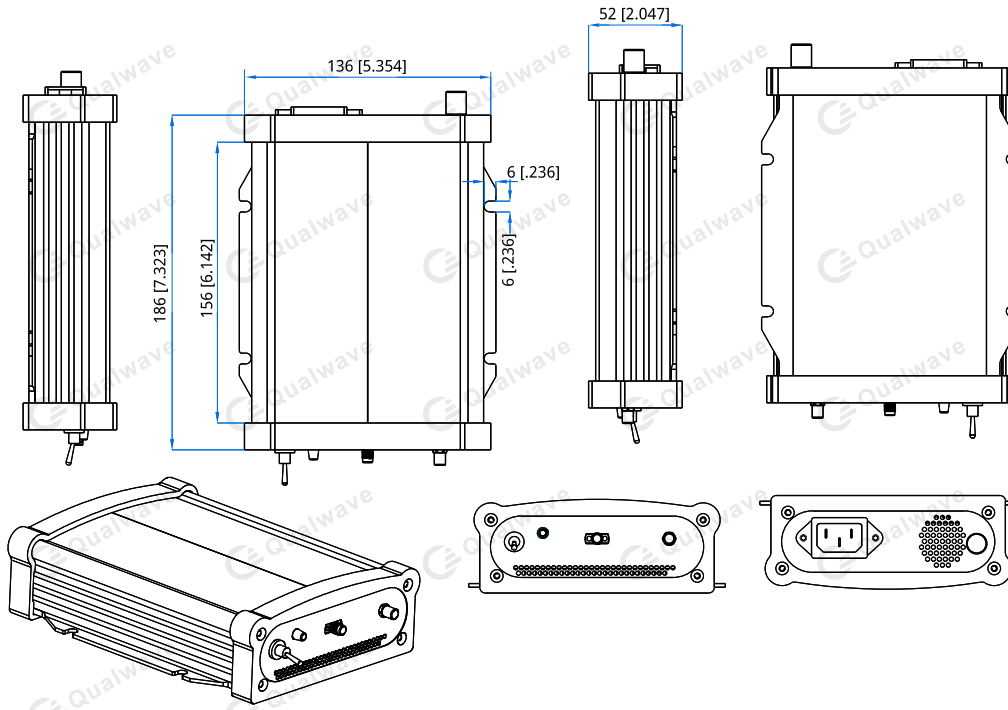

Unit: mm [in]

Tolerance: ±0.5mm [±0.02in]