

QWSD-187

DPDT, 3.95~5.85GHz, WR-187

Features:
 * Low VSWR
 * High Isolation
 * Low Insertion Loss

Applications:
 * Wireless
 * Transmitter
 * Laboratory Test
 * Radar

Electrical

Frequency:	3.95~5.85GHz
Insertion Loss:	0.02dB max.
VSWR:	1.05 max.
Isolation:	80dB min.
Voltage:	24±2V DC
current:	1.2A@24V DC

Mechanical

Interface:	WR-187
Operation Life:	0.1M Cycles
Switching Time:	80mS

Environmental

Operating Temperature:	-40~+85°C
Extended Temperature:	-55~+85°C
Non-operating temperature:	-55~+105°C

Pin Numbering

Pin	Function	Pin	Function
A	VDC	D	Indicator1
B	GND	E	COM(Indicator)
C	VDC	F	Indicator2

Control Logic

Position	A	B	C	RF Working Condition	Indicator status
POS 1	VDC	GND	NC	PORT1-PORT2 ON PORT3-PORT4 ON	D-E ON F-E OPEN
POS 2	NC	GND	VDC	PORT1-PORT4 ON PORT3-PORT2 ON	D-E OPEN F-E ON

Outline Drawings

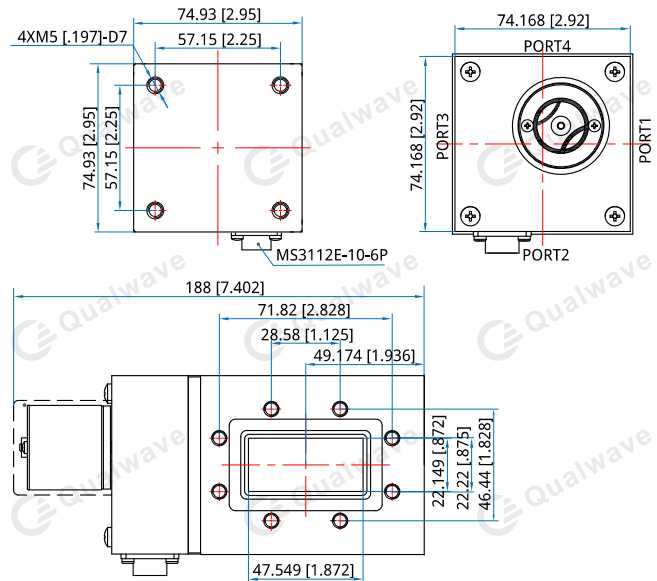

Unit: mm [in]
 Tolerance: ±0.2mm [±0.008in]

Additional Options

TTL: T
 Indicators: I
 Extended Temperature: Z

How To Order

QWSD-187-XYZ

X: Voltage. +15V: F, +24V: K.
 Y: Interface Circular connector: 2.
 Z: Additional Options.

Examples:

To order a Waveguide Switch, DPDT, WR-187, +24V, TTL, Indicators, specify QWSD-187-K2TI.

Customization is available upon request.

Driving Schematic Diagram