

QPS2-4000-8000-A-2

SPDT, 4~8GHz, Absorptive

Features:

- * Low Insertion Loss
- * High Isolation

Applications:

- * Wireless
- * Transmitter
- * Laboratory Test
- * Radar

Electrical

Frequency:	4~8GHz
Insertion Loss:	1.5dB max.
Isolation:	80dB min.
VSWR:	1.5 max.
Input Power:	30dBm max.
Voltage/Current:	+5V@100mA max.
	-5V@50mA max.
Control:	TTL High - 1
	TTL Low/NC - 0

Mechanical

Size ^{*1} :	26*18*10.2mm
	1.024*0.709*0.402in
Switching Time:	100nS max.
RF Connectors:	SMA Female
Power Supply Connectors:	Feed Through/Terminal Post
Housing Material:	Nickel plated aluminum
Mounting:	2-Φ2.7mm through-hole

[1] Exclude connectors.

Environmental

Operating Temperature:	-40~+85°C
Non-operating Temperature:	-55~+125°C

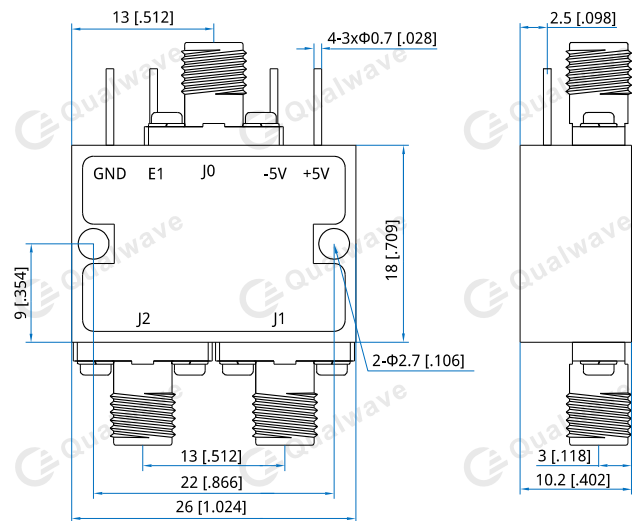
Outline Drawings

Unit: mm [in]

Tolerance: ±0.2mm [±0.008in]

Control True Table

E1	Connection
0	J0 - J1 On
1	J0 - J2 On

How To Order

[QPS2-4000-8000-A-2](#)

Customization is available upon request.