

QRJ1-50000-14

Single Channel, DC~50GHz, 14.5mm

- | | |
|-------------------------------|------------------------------|
| Features: | Applications: |
| * Low VSWR | * High Speed Digital Signal |
| * Low VSWR Flatness | Transmission |
| * Low Insertion Loss Flatness | * Analog Signal Transmission |

Electrical

Frequency:	DC~50GHz
VSWR:	1.5 max.@DC~18GHz
	1.8 max.@18~26.5GHz
	2.6 max.@26.5~50GHz
VSWR Flatness:	0.15 max.
Insertion Loss:	0.8dB max.@DC~18GHz
	1.2dB max.@18~26.5GHz
	2.5dB max.@26.5~50GHz
Insertion Loss Flatness:	0.15dB max.
Average Power:	20W max.@18GHz
Impedance:	50Ω

Mechanical

Connectors:	2.4mm female
Rotating Speed:	100RPM
Operation Life:	5M Cycles
IP Grade:	IP51

Environmental

Operating Temperature:	-30~+80°C
Operating Humidity:	0~85%

Outline Drawings

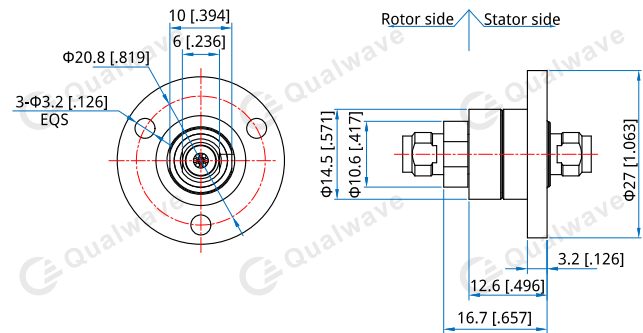

Unit: mm [in]
Tolerance: ±0.2mm [±0.008in]

How To Order

QRJ1-50000-14

Customization is available upon request.