

QLB-7750-8500-60-75

7.75~8.5GHz, 60dB, 75K, X-Band

Features:

- * Broad Band
- * Low Noise Temperature
- * Low Input VSWR

Applications:

- * Fixed Station
- * Mobile Station
- * Laboratory Test

Electrical

Input RF Frequency:	7.75~8.5GHz
Output IF Frequency:	950~1700MHz
LO Frequency:	6.8GHz
Gain:	60dB
Gain Flatness:	±1.5dBp-p max. @500MHz ±1.5dBp-p max. @750MHz
Noise Temperature:	75K
Output Power (Psat):	10dBm min.
Input/Output VSWR:	1.5/2.0
Phase Noise:	-60dBc/Hz@100Hz max. -70dBc/Hz@1KHz max. -85dBc/Hz@10KHz max. -95dBc/Hz@100KHz max.
External Reference:	10MHz, 0±3dBm
Voltage:	12~18V DC
Current:	200mA typ.
Impedance:	50Ω

Mechanical

Size*1:	118.9*63.5*44.5mm 4.681*2.5*1.752in
RF Input Waveguide Size:	WR-112 (BJ84)
Flange:	FDM84
Ext.ref. Input(10MHz)/	50Ω N Female/50Ω SMA
IF Output Connector:	Female/75Ω F Inch Thread Female
Weight:	500g max.

[1] Exclude connectors.

Environmental

Operating Temperature:	-40~+60°C
Operating Humidity:	0~100%

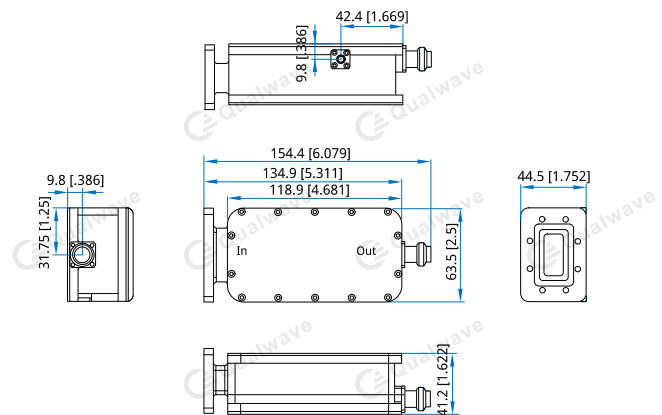
Outline Drawings

Unit: mm [in]

Tolerance: ±0.5mm [±0.02in]

How To Order

QLB-7750-8500-60-75-Z

Z: Output connector type

Connector naming rules:

- N - N female
- S - SMA female
- F - F Inch Thread female

Examples:

To order a Block Downconverters (LNBs), 7.75~8.5GHz, 60dB, 75K, N female, specify QLB-7750-8500-60-75-N.

Customization is available upon request.