

QLB-3400-4200-60-45

3.4~4.2GHz, 60dB, 45K, C-Band

Features:

- * Broad Band
- * Low Noise Temperature
- * Low Input VSWR

Applications:

- * Fixed Station
- * Mobile Station
- * Laboratory Test

Electrical

Input RF Frequency:	3.4~4.2GHz
Output IF Frequency:	950~1750MHz
LO Frequency:	5.15GHz
Gain:	60dB
Gain Flatness:	±2.0dBp-p/500MHz max.
Noise Temperature:	45K
Output Power (Psat):	10dBm min.
Input/Output VSWR:	2.5/2.0
Phase Noise:	-60dBc/Hz@100Hz max. -70dBc/Hz@1KHz max. -80dBc/Hz@10KHz max. -90dBc/Hz@100KHz max.
Frequency Stability:	±1ppm@Internal Reference
External Reference:	10MHz, 0±3dBm
Voltage:	12~18V DC
Current:	200mA typ.
Impedance:	50Ω

Mechanical

Size*1:	153.5*99.6*69.9mm 6.043*3.921*2.752in
RF Input Waveguide Size:	WR-229 (BJ40)
Flange:	FDM40
Ext.ref. Input(10MHz)/	50Ω N Female/50Ω SMA
IF Output Connector:	Female/75Ω F Inch Thread Female
Weight:	360g

[1] Exclude connectors.

Environmental

Operating Temperature:	-40~+60°C
Operating Humidity:	0~100%

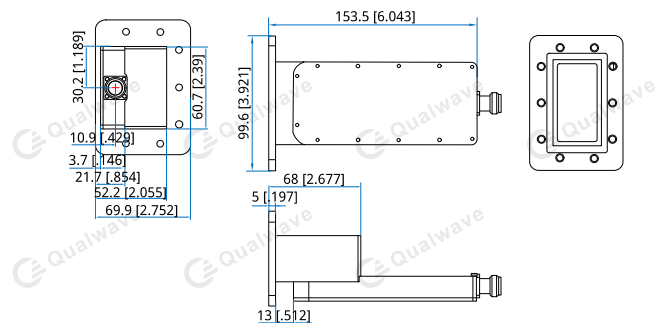
Outline Drawings

Unit: mm [in]

Tolerance: ±0.5mm [±0.02in]

How To Order

QLB-3400-4200-60-45-Z

Z: Output connector type

Connector naming rules:

- N - N female
- S - SMA female
- F - F Inch Thread female

Examples:

To order a Block Downconverters (LNBS), 3.4~4.2GHz, 60dB, 45K, N female, specify QLB-3400-4200-60-45-N.

Customization is available upon request.